



Hansagreen
LED

*Dark Sky
Logo*

FALCON G

Falcon G-XXX-KXX



+971 65 260 706

sales-me@hansagreen.com

www.hansagreen.com



PRODUCT HIGHLIGHTS

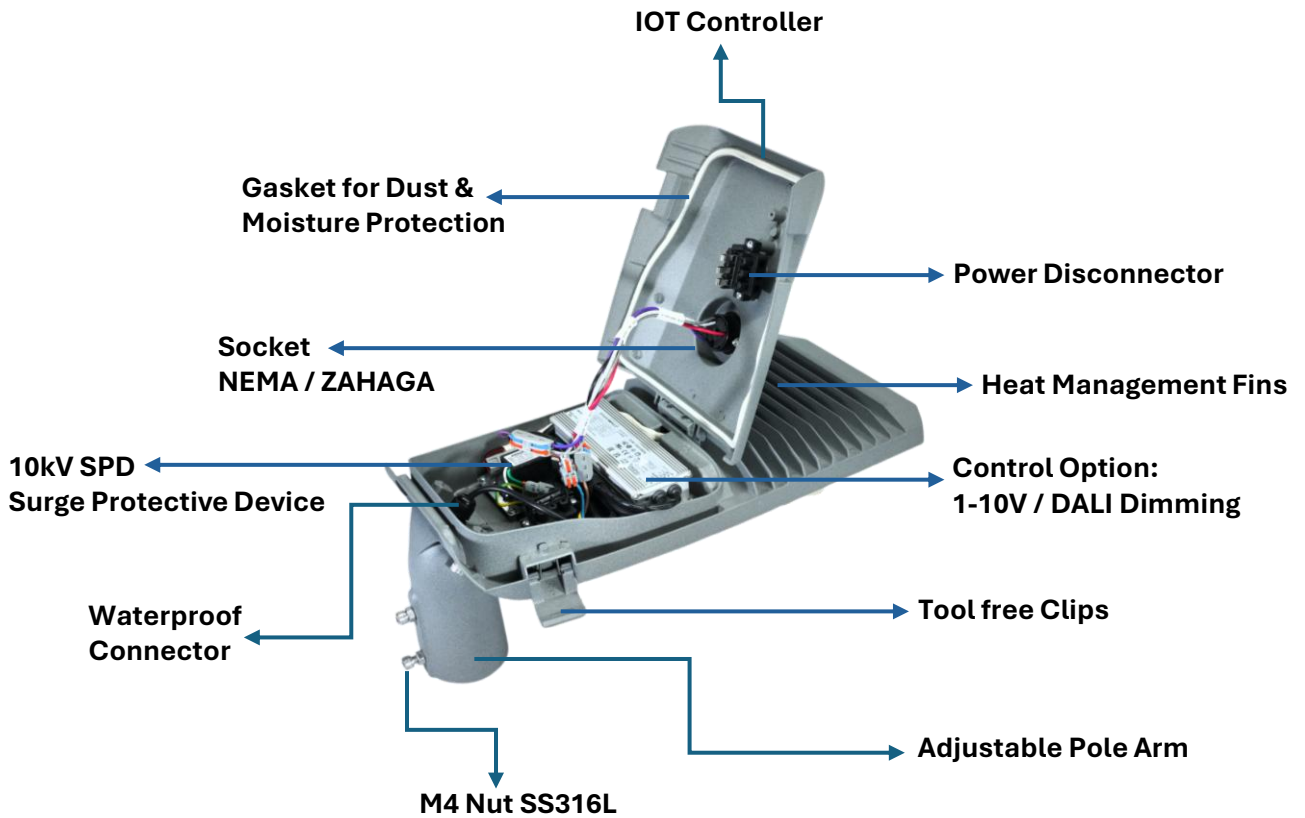

FEATURES



Thermal Management



Corrosion Resistance



Vibration Resistance



Easy Maintenance

FALCON G

Falcon G-100-K30



DESCRIPTION

Falcon G is a high-performance, energy-efficient street lighting solution designed to deliver uniform illumination for urban and industrial environments. With advanced optics, it ensures optimal lighting for applications such as roads, highways, parking areas, residential communities, and commercial spaces, while offering reliable performance and low maintenance.



Conformity



مجلس أبوظبي
للجودة والمطابقة
Abu Dhabi Quality &
Conformity Council



Compliant with



Tested for Safety



Salt
Spray



3G
Vibration



Photobiological
Safety



Insulation Class



Protection Class



+971 65 260 706

sales-me@hansagreen.com

www.hansagreen.com



ORDERING CODE

Falcon G-100-K30-xx-xxx-XxxXx

PRODUCT NAME	CATEGORY	POWER	CCT	BODY COLOUR	CONTROL OPTIONS	ACCESS
FALCON	G	XXX	KXX	xx	xxx	XxxXx
FALCON	SERIES	UP TO 100W	K30 (3000K)	GR - GREY	DAL - (DALI)	S(ne/zh)C(i/p) Smart Socket(S) (ne - nema /zh - zhaga) Controller(C) (i - IoT /p - photocell)
		UP TO 80W	K27 (2700K)	WH - WHITE	10V - 1-10V	
				SP - SPECIAL	OF - ON/OFF	

Example: For the street light model FALCON G with a power rating of 100W, CCT 3000K, Grey body colour, 1-10V dimmable controller, with Nema Socket and Photocell will be Falcon G-100-K30-GR-10V-SneCp.

TECHNICAL SPECIFICATION

LUMINAIRE DETAILS

PRODUCT NAME	FALCON G
PRODUCT TYPE	LED STREET LIGHT
PRODUCT CODE	Falcon G-100-K30
MAXIMUM HOUSING POWER	UP TO 100W

HOUSING DETAILS

BODY MATERIAL	CORROSION-RESISTANT ALUMINIUM DIE-CAST
LENS	UV-STABILIZED POLYCARBONATE (PC) LENS
OPTICS	SYMMETRIC/ASYMMETRIC
BODY COLOUR	GREY / WHITE / SPECIAL

CHIP DETAILS

LIGHT SOURCE	SMD LEDs
AVAILABLE CCT	3000K
MACADAM BINNING	STEP 4
CRI	≥70





TECHNICAL SPECIFICATION

OPTICAL DETAILS

BEAM ANGLE	106.7°
OPTICAL TYPE	IES Type II (Very Short)
BUG RATING	B3-U0-G2
ULOR(Upward Light Output Ratio)	0% (U0 – Zero Uplight)

LUMINAIRE PERFORMANCE

LUMINAIRE FLUX	15,265 lm(@ 100.64W Tested)
EFFICACY	151.68 lm/W

ENVIRONMENTAL CONDITIONS

AMBIENT TEMPERATURE (TA)	-20°C TO +50°C
HUMIDITY	RH 10–95%

PROTECTION & DURABILITY

IP RATING	IP66
IK RATING	IK08

ELECTRICAL DETAILS

NOMINAL VOLTAGE (AC)	100–240 VAC
FREQUENCY	50/60 HZ
LED DRIVER CURRENT	650 mA
POWER FACTOR	≥0.90
RATED POWER	100W
THD	≤20%
CONTROL OPTIONS	DALI, 1–10V DIMMING, ON/OFF





PHOTOMETRIC DETAILS

Polar Plot

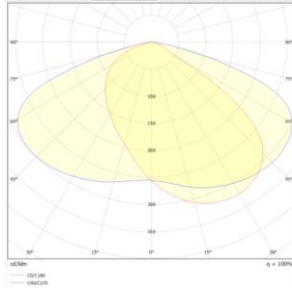

Linear Plot

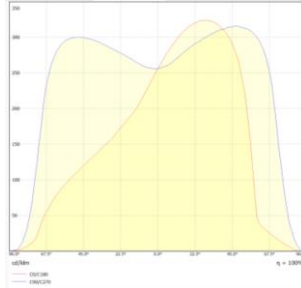

Type II Short

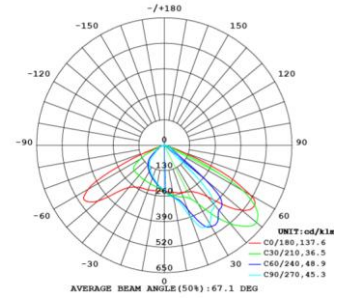

Polar Plot

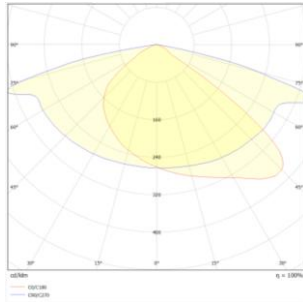

Linear Plot

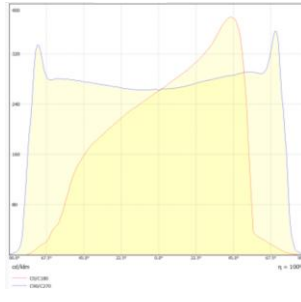

Type II Medium

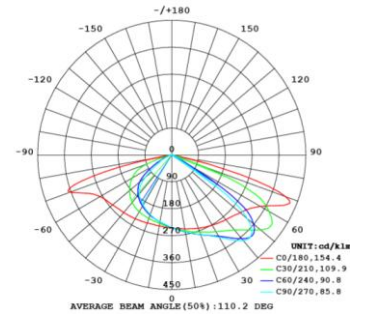

Polar Plot

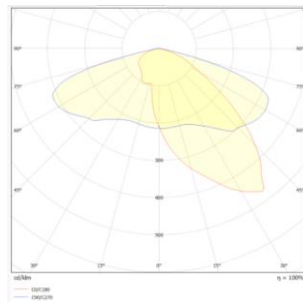

Linear Plot

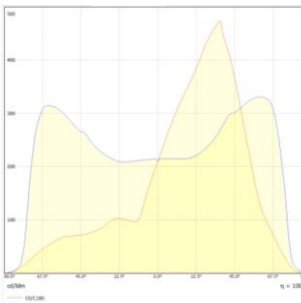

Type III Medium

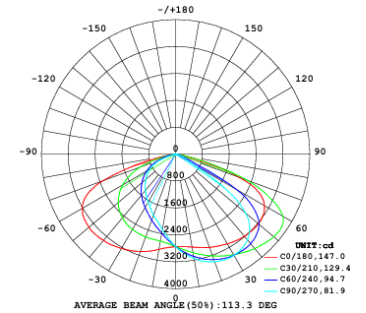

Polar Plot

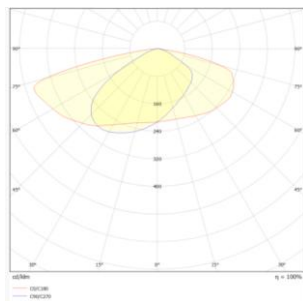

Linear Plot

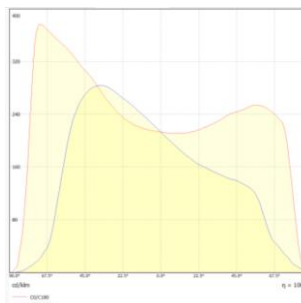

Type III Short

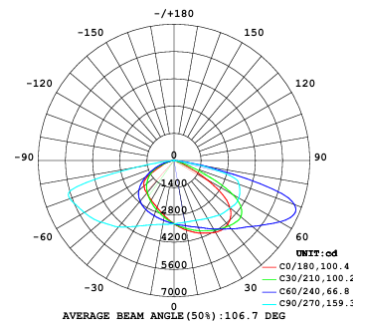

CUSTOM DIMMING PROFILE

The Street Light luminaire supports 1–10 V dimming as well as DALI dimming, allowing smooth and reliable adjustment of light output according to the required ambiance or energy-saving needs. By integrating with compatible lighting control systems, the brightness can be adjusted from full output to lower levels while maintaining stable performance.

- 1–10 V dimming: Simple analog dimming.
- DALI dimming: Digital, programmable dimming for advanced control.

This feature is ideal for pathways, landscapes, and architectural outdoor applications where lighting levels may need to be adjusted at different times of the night, improving visual comfort while reducing energy consumption

DIMENSIONAL DETAILS

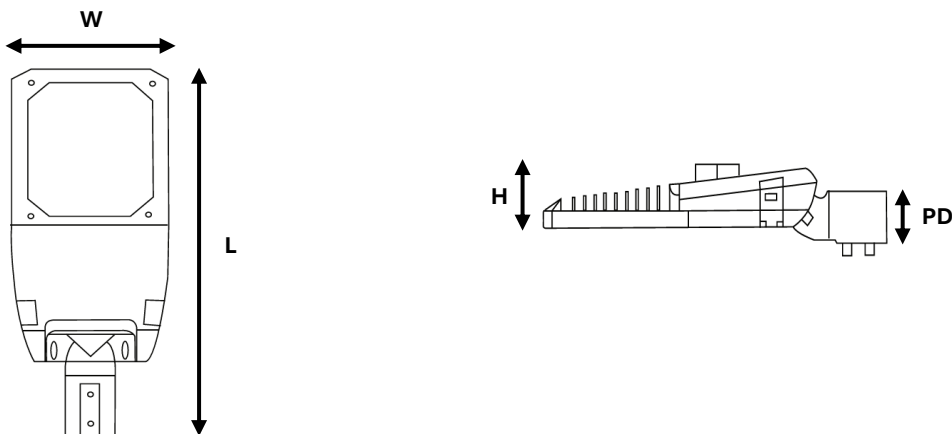

DIMENSIONS	
LENGTH (L)	602 mm
WIDTH (W)	243 mm
HEIGHT (H)	120 mm
POLE DIA (PD)	65 mm

FALCON G

Falcon G-100-K30



MOUNTING TYPE

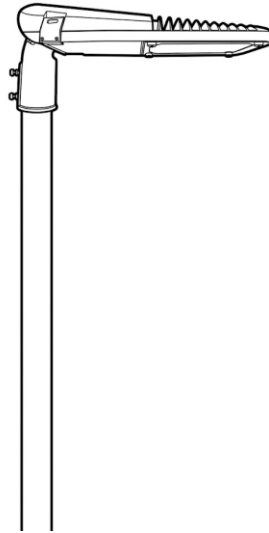

Post-Top mounting

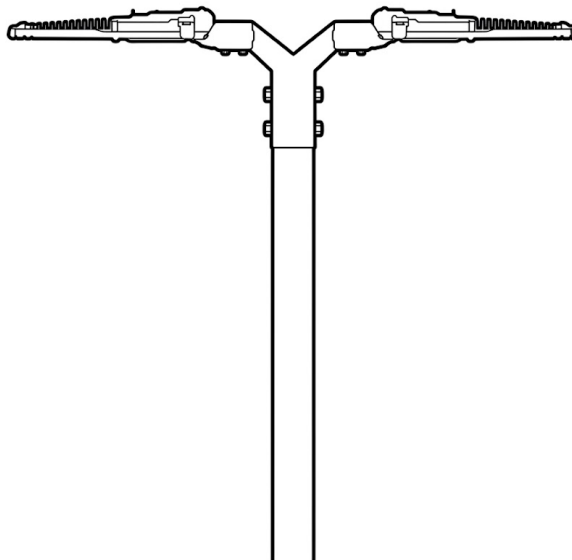

Spigot mounting

GENERIC INSTALLATION STEPS

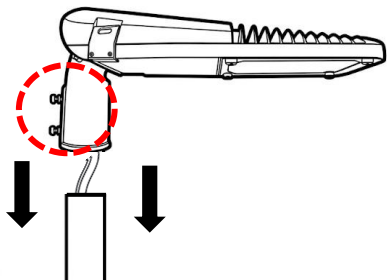

1. Pole Preparation

Remove the M8×25 Allen key fasteners from the mounting arm. Carefully route the supply cable through the pole and ensure it is positioned correctly to prevent damage during installation.

2. Fixture Mounting

Route the cable through the pole and align the luminaire with the mounting arm. Reinstall the M8×25 Allen key fasteners and tighten them securely to ensure proper fixture attachment.

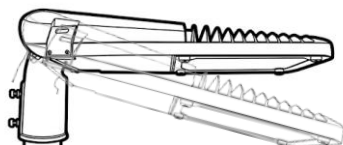
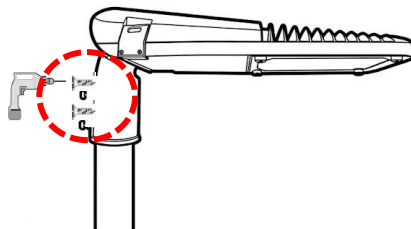

3. Luminaire Tilt

Adjust the luminaire to the required angle and secure it to the pole arm. Tighten the M8×25 Allen key fasteners firmly to lock the position.

Note: The tilt is mechanically limited to a maximum of 5° above horizontal to prevent upward light emission.



Don't touch the LED



Do not dispose with
normal waste



Ambient Temperature
Ta 50°

IP66



TILT ANGLE INSTRUCTION

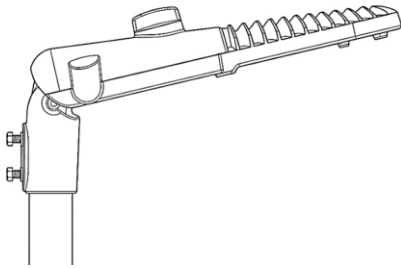

Before limiter

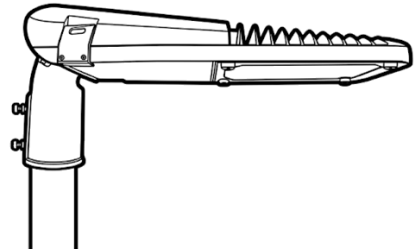

After limiter

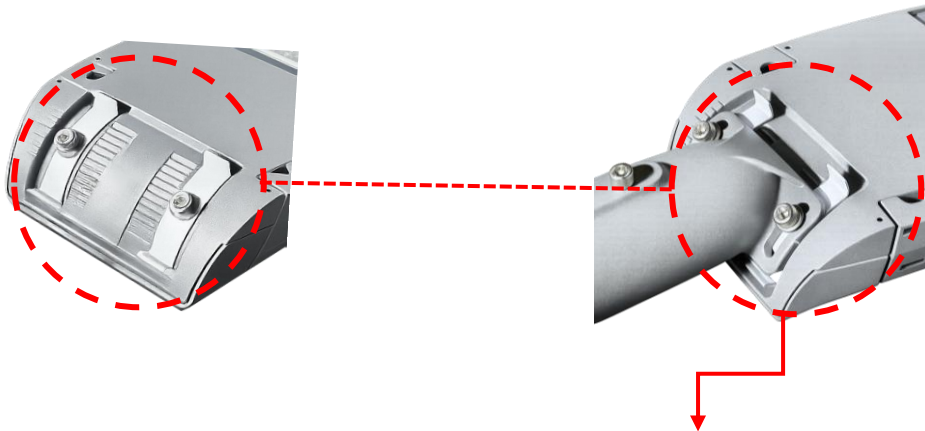

Tilt adjustment locking mechanism

- Restricts adjustment above 5° (horizontal position)
- Integrated **mechanical tilt-stop mechanism** for reliable angle control.
- Secure **locking mechanism** prevents unintended movement.
- Supports DarkSky-friendly lighting applications.

PRODUCT ACCESSORIES

Smart Sockets & Controllers

Smart Interfaces



NEMA 5-Pin



NEMA 7-Pin



Zhaga Book 18

Smart Controllers



NEMA Node



Zhaga Node