



Hansagreen
LED

CORVUS PRO

CVSP-PRJ-45W-XXXXK

*Dark Sky
Logo*



+971 65 260 706

| sales-me@hansagreen.com

| www.hansagreen.com

CORVUS PRO

CVSP-PRJ-45W-XXXXK



PRODUCT HIGHLIGHTS

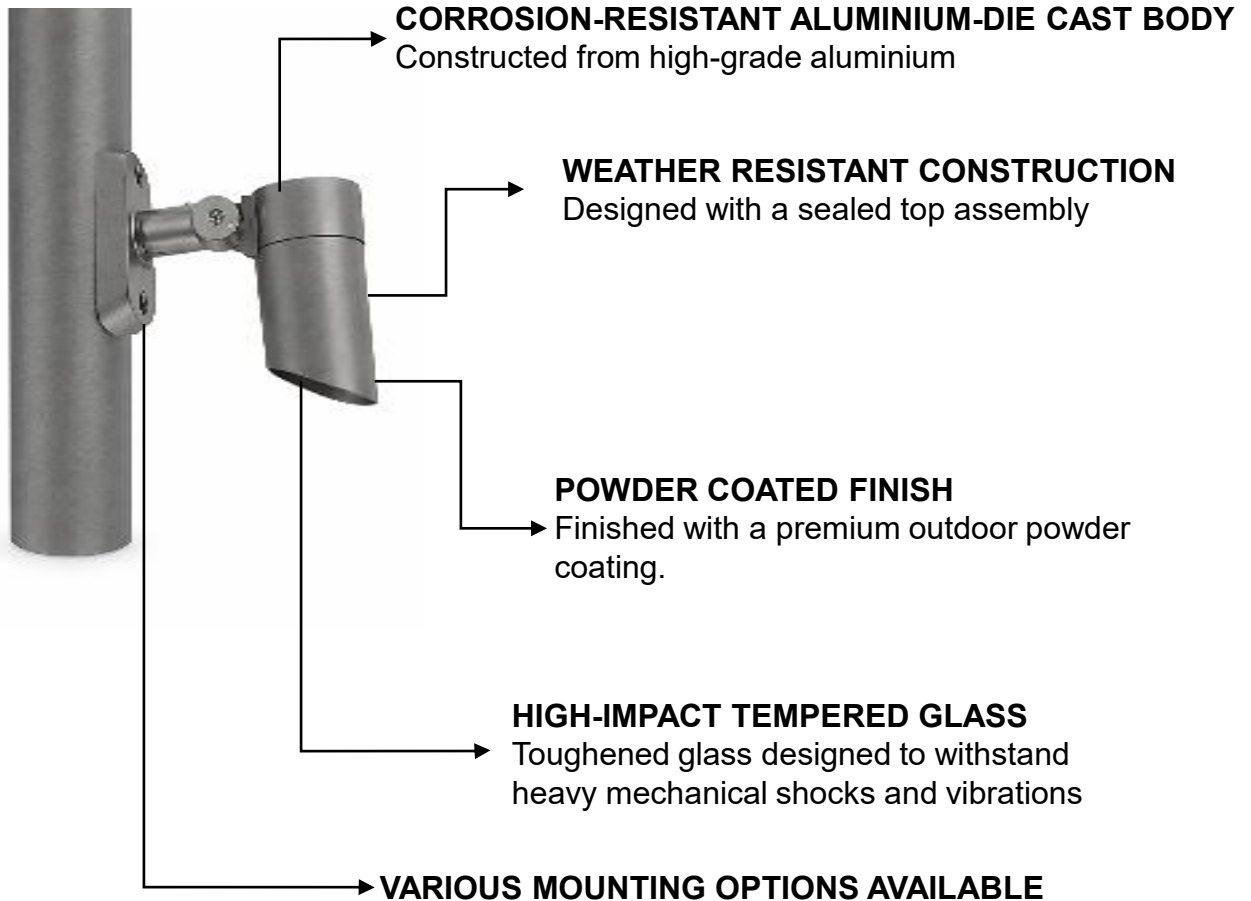

FEATURES



Thermal
Management



Corrosion
Resistance



Vibration
Resistance



Easy
Maintenance

Note: DarkSky Approved when mounted in the downward position only



+971 65 260 706

sales-me@hansagreen.com

www.hansagreen.com

CORVUS PRO

CVSP-PRJ-45W-XXXXK

Dark Sky
Logo

 **Hansagreen**
LED

DESCRIPTION

CORVUS PRO is a high-performance outdoor LED luminaire designed for precise directional lighting. Its compact, weather-resistant construction makes it ideal for façade, landscape, and architectural applications, featuring adjustable brackets with versatile wall and surface mounting options for flexible installation.



Conformity

CB



مجلس أبوظبي
للجودة والمطابقة
Abu Dhabi Quality &
Conformity Council 

Compliant with



Tested for Safety



Insulation Class



Protection Class



+971 65 260 706

sales-me@hansagreen.com

www.hansagreen.com



ORDERING CODE

CVSP-PRJ-45W-2700K-xx-xx-xxx

PRODUCT NAME	CATEGORY	PRODUCT FAMILY	POWER	CCT	BODY COLOUR	CONTROL OPTIONS	ACCESSORIES
CVS	P	PRJ	XXW	XXXXK	xx	xx	xxx
CORVUS	PRO	PROJECTOR	UP TO 45W	2700K	GR (GREY)	DA (DALI)	SUM SU (SURFACE) M (MOUNT)
				3000K	SP (SPECIAL)	10V (1-10V)	SSM SS (SHORT STEM) M (MOUNT)
							PTM PT (POLE TOP) M (MOUNT)
							SPM SP (SIDE POLE) M (MOUNT)
							WAM WA (WALL) M (MOUNT)
							PCM PC (POLE CLAMP) M (MOUNT)

Example: For the projector light model CORVUS PRO with a power rating of 45W, CCT 2700K, Grey body colour, 1-10V dimmable controller, Pole Top Mount will be CVSP-PRJ-45W-2700K-GR-10V-PTM

TECHNICAL SPECIFICATION

LUMINAIRE DETAILS	
PRODUCT NAME	CORVUS PRO
PRODUCT TYPE	LED FLOOD LIGHT
PRODUCT CODE	CVSP-PRJ-45W-XXXXK
MAXIMUM HOUSING POWER	UP TO 45W
HOUSING DETAILS	
BODY MATERIAL	CORROSION-RESISTANT ALUMINIUM DIE-CAST
LENS	REFLECTOR AND CLEAR GLASS
BODY COLOUR	GREY / SPECIAL
CHIP DETAILS	
LIGHT SOURCE	COB
AVAILABLE CCT	2700K / 3000K
MACADAM BINNING	STEP 3
CRI	≥80





TECHNICAL SPECIFICATION

OPTICAL DETAILS

BEAM ANGLE	35.5°
OPTICS	IES Type V (Very Short)
BUG RATING	B3-U0-G0
ULOR (Upward Light Output Ratio)	0% (U0 – Zero Uplight)

LUMINAIRE PERFORMANCE

LUMINAIRE FLUX	4214 lm (@41.39W Tested)
EFFICACY	101.80 lm/W

ENVIRONMENTAL CONDITIONS

AMBIENT TEMPERATURE (TA)	-20°C TO +50°C
HUMIDITY	RH 10–95%

PROTECTION & DURABILITY

IP RATING	IP66
IK RATING	IK10

ELECTRICAL DETAILS

NOMINAL VOLTAGE	220-240 VAC
FREQUENCY`	50/60 HZ
LED DRIVER CURRENT	600 mA
POWER FACTOR	≥0.90
THD	≤20%
RATED POWER	45W
CONTROL OPTIONS	DALI, 1–10V DIMMING





PHOTOMETRIC DETAILS

Polar Plot

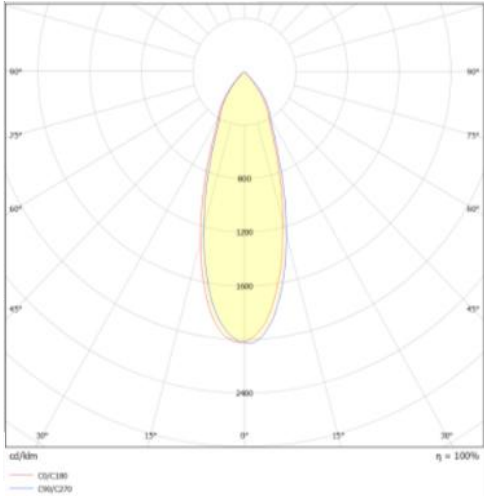

Linear Plot

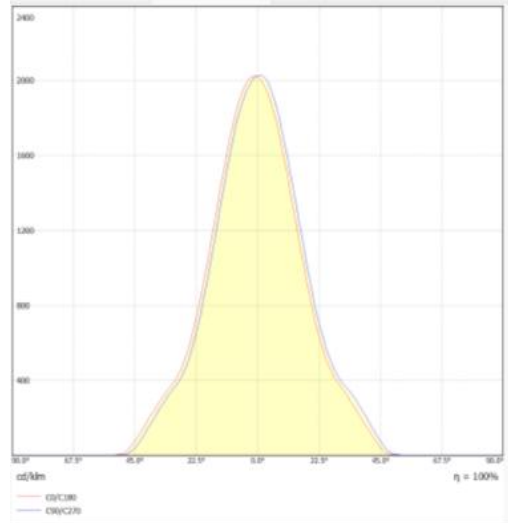

CVSP-PRJ-45W-XXXXK

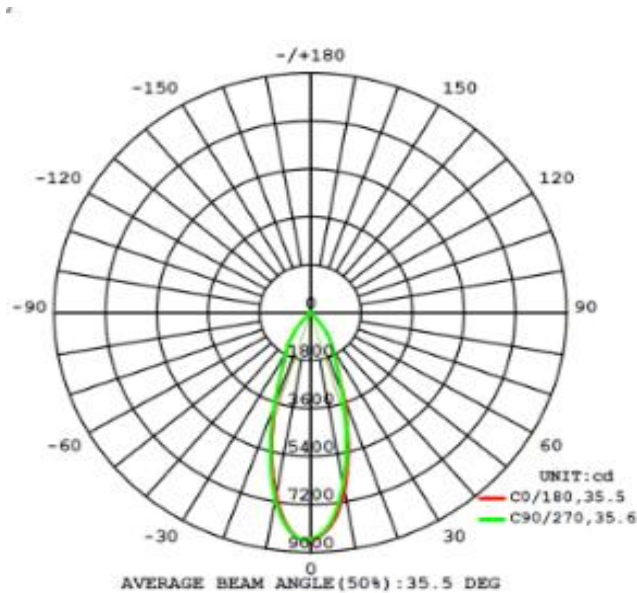



CUSTOM DIMMING PROFILE

This luminaire supports both 1–10 V and DALI dimming, enabling smooth and reliable adjustment of light output to suit different applications or energy-saving requirements. By integrating with compatible lighting control systems, the brightness can be easily tuned from full output to lower levels while maintaining consistent performance.

- 1–10 V dimming: Simple analog dimming for straightforward control.
- DALI dimming: Digital, programmable dimming for advanced lighting management.

This feature is ideal for façades, architectural highlights, and outdoor areas where lighting levels may need to be adjusted throughout the evening, enhancing visual comfort while reducing energy consumption.

DIMENSIONAL DETAILS

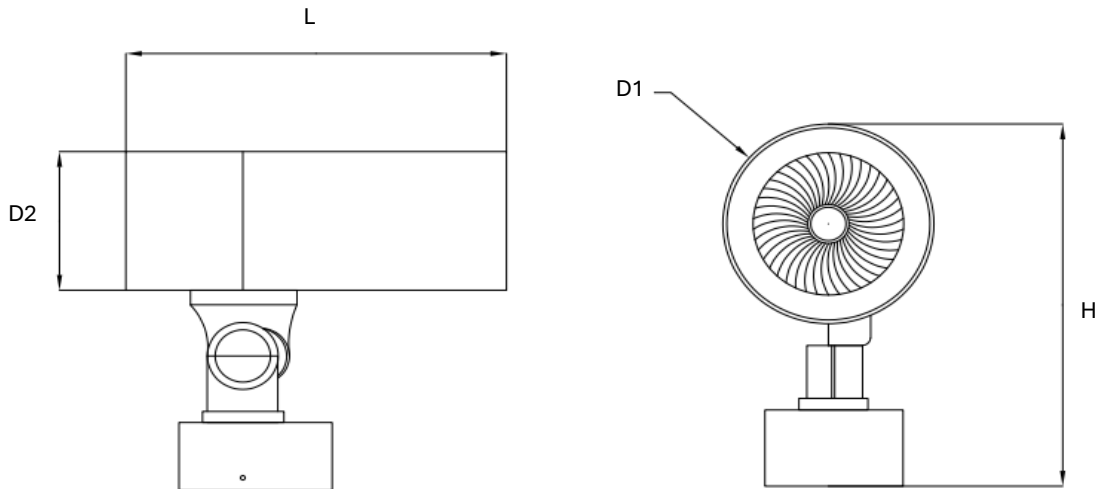

DIMENSIONS	
LENGTH	193 mm
DIAMETER D1	120 mm
DIAMETER D2	125 mm
HEIGHT	285 mm



TILT LIMITER

Note: DarkSky Approved when mounted in the downward position only

The tilt limiter ensures that the luminaire cannot be adjusted above 0° (horizontal).

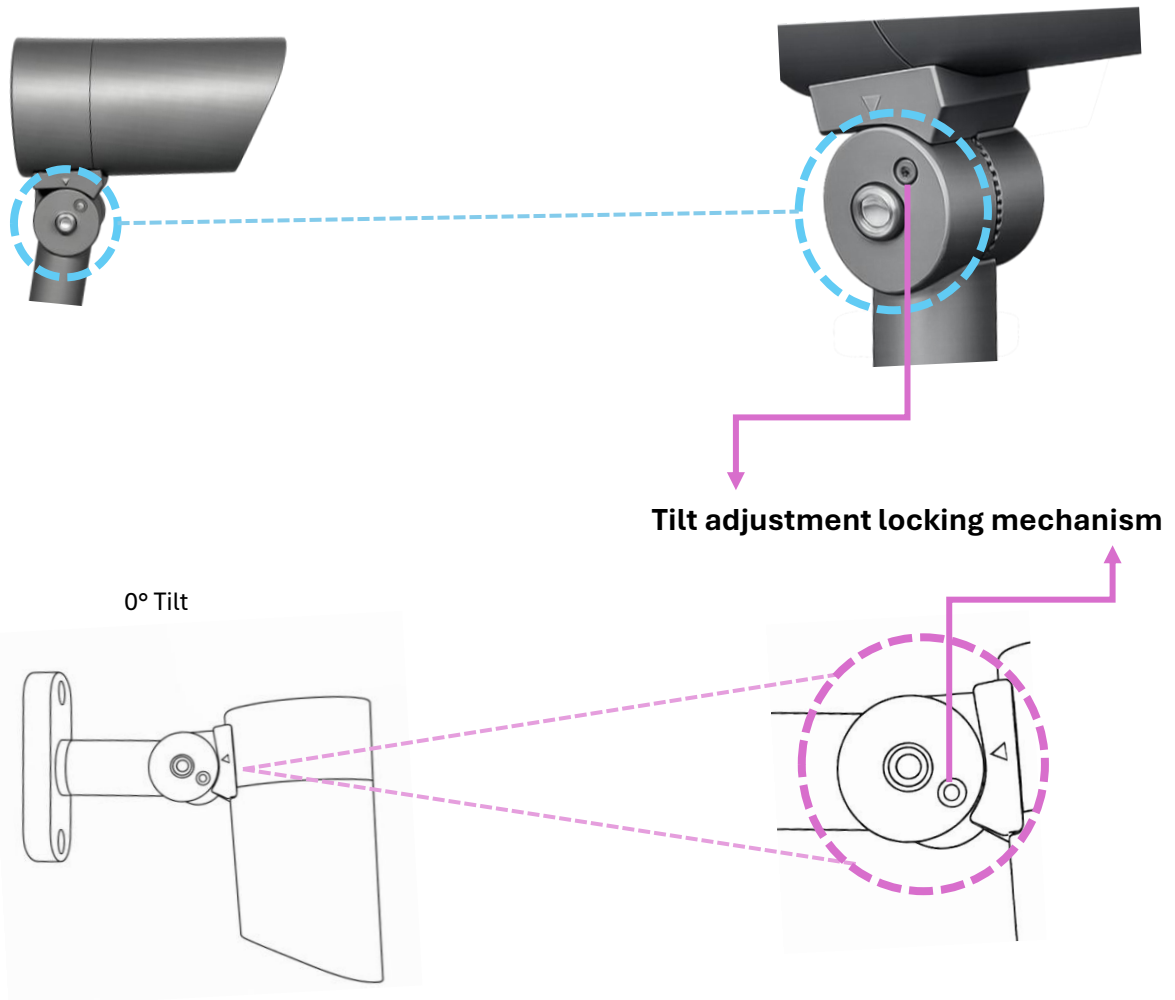

- Restricts adjustment above **0° (horizontal position)**
- Integrated **mechanical tilt-stop mechanism** for reliable angle control.
- Secure **locking mechanism** prevents unintended movement.
- Supports DarkSky-friendly lighting applications.



SURFACE MOUNT INSTALLATION STEPS

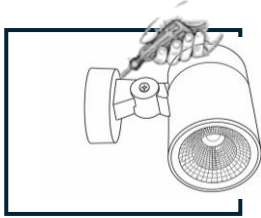

1. Fix the Mounting Bracket:

Install and secure the mounting bracket to the surface using suitable fasteners.



2. Fixture Mounting:

Mount the luminaire onto the bracket and secure the fixture to the Surface for direct illumination as required.

SHORT STEM MOUNT INSTALLATION STEPS



1. Fix the Pole plate:

Mount the bracket, secure it to the Stem using screws.



2. Mount the light:

Attach the luminaire to the mounting bracket and secure it using the supplied Allen key.

POLE MOUNT INSTALLATION STEPS

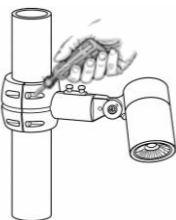

1. Fix the Pole plate:

Mount the bracket plate, secure it to the Pole using screws.

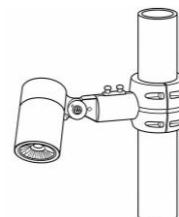

2. Mount the light:

Mount the luminaire to the Bracket tilt it downward to adjust the direct illumination where required



SIDE POLE MOUNT INSTALLATION STEPS



1. Fix the Side Pole plate:

Install and secure the side pole mounting plate to the pole using the supplied fasteners.



2. Mount the light:

Attach the luminaire to the mounting plate and secure it using the supplied Allen key.

WALL MOUNT INSTALLATION STEPS

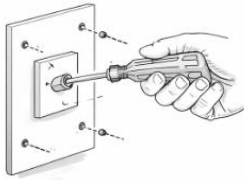

1. Fix the Wall plate:

Install and secure the wall mounting plate to the surface using appropriate fasteners

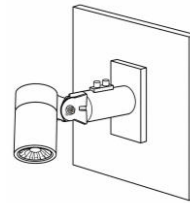

2. Mount the light:

Attach the luminaire to the mounting plate and secure it using the supplied Allen key.

POLE CLAMP MOUNT INSTALLATION STEPS

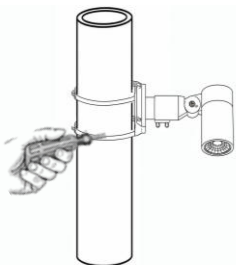

1. Fix the Mounting Bracket:

Secure the bracket firmly around the pole at the desired height.

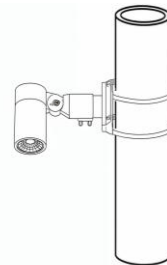

2. Fixture Mounting:

Mount the luminaire onto the bracket and secure it using the supplied Allen key as required.



MOUNTING METHODS AND ACCESSORIES

(SUM) Surface Mount

Directly installed on a solid surface, providing stable downward illumination for landscape and architectural lighting.



(STM) Short Stem Mount

Mounted on a short stem to slightly elevate the luminaire for improved beam clearance.

(PTM) Pole Top Mount

Installed on top of a pole, delivering elevated and controlled downward illumination.



(SPM) Side Pole Mount

Mounted on the side of a pole using a rigid arm bracket..

(WAM) Wall Mount

Fixed onto vertical surfaces to provide focused downward lighting for façades and features.



(PCM) Pole Clamp Mount

Clamp bracket enables secure pole installation without drilling, ensuring flexible positioning.