

BOLLAX Z

BLXZ-BLD-20W-XXXXK

*Dark Sky
Logo*





PRODUCT HIGHLIGHTS

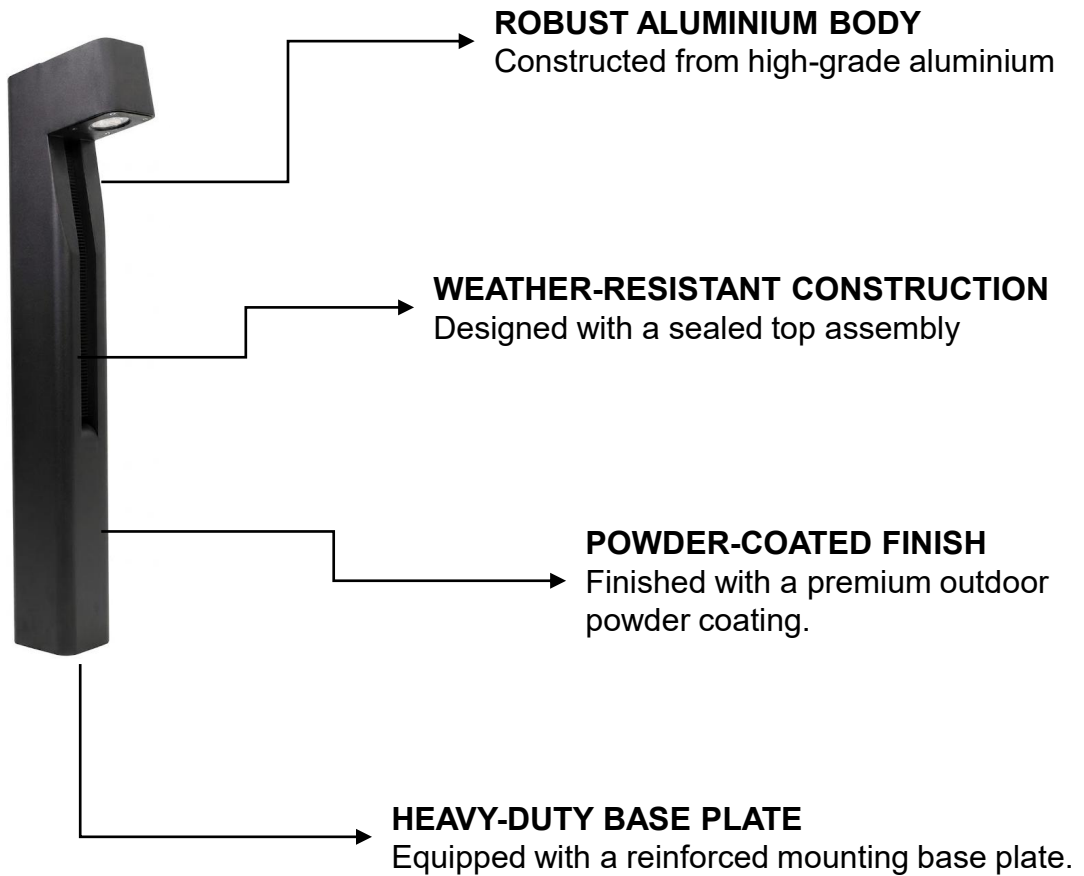

FEATURES



Thermal Management



Corrosion Resistance



Vibration Resistance



Easy Maintenance



DESCRIPTION

BOLLAX Z is a durable outdoor LED lighting solution engineered to perform reliably in demanding environmental conditions. With its weather-resistant construction and sleek, modern design, it seamlessly combines strength with aesthetic appeal. Ideal for pathways, landscapes, and outdoor environments.



Conformity

CB



مجلس أبوظبي
للجودة والمطابقة
Abu Dhabi Quality &
Conformity Council



Compliant with



Tested for Safety



Salt
Spray



3G
Vibration



Photobiological
Safety

Insulation Class



Protection Class





ORDERING CODE

BLXZ-BLD-20W-XXXXK-xx-xxx-xx

PRODUCT NAME	CATEGORY	PRODUCT FAMILY	POWER	CCT	BODY COLOUR	CONTROL OPTIONS	DIMENSION
BLX	Z	BLD	XXW	XXXXK	xx	xxx	xx
BOLLAX	SHAPE	BOLLARD	UP TO 20W	2700K	BL (BLACK)	10V (1-10V)	TH (1000-1200 mm)
				3000K	SP (SPECIAL)	DAL (DALI)	MH (600 mm)

Example: For the bollard model Bollax Z with a power rating of 20W, CCT 2700K, black body colour, DALI dimmable controller, and a height of 1000 mm, the ordering code will be BLXZ-BLD-20W-2700K-BL-DAL-TH

TECHNICAL SPECIFICATION

LUMINAIRE DETAILS

PRODUCT NAME	BOLLAX Z
PRODUCT TYPE	LED BOLLARD LIGHT
PRODUCT CODE	BLXZ-BLD-20W-XXXXK
MAXIMUM HOUSING POWER	UP TO 20W

HOUSING DETAILS

BODY MATERIAL	CORROSION-RESISTANT ALUMINIUM DIE-CAST
LENS	TEMPERED CLEAR GLASS
OPTICS	SYMMETRIC
BODY COLOUR	BLACK / SPECIAL

CHIP DETAILS

LIGHT SOURCE	COB
AVAILABLE CCT	2700K - 3000K
MACADAM BINNING	STEP 4
CRI	≥90





TECHNICAL SPECIFICATION

OPTICAL DETAILS

BEAM ANGLE	96.2°
OPTICS	IES Type V (Very Short)
BUG RATING	B1-U0-G0
ULOR(Upward Light Output Ratio)	0% (U0 – Zero Uplight)

LUMINAIRE PERFORMANCE

LUMINAIRE FLUX	1,728 lm (@ 20.42 W Tested)
EFFICACY	84.59 lm/W

ENVIRONMENTAL CONDITIONS

AMBIENT TEMPERATURE (TA)	-20°C TO +50°C
HUMIDITY	RH 10–95%

PROTECTION & DURABILITY

IP RATING	IP66
IK RATING	IK09

ELECTRICAL DETAILS

NOMINAL VOLTAGE	220–240 VAC
FREQUENCY	50/60 HZ
LED DRIVER CURRENT	500 mA
POWER FACTOR	≥0.90
RATED POWER	20W
THD	≤20%
CONTROL OPTIONS	DALI, 1–10V DIMMING





CUSTOM DIMMING PROFILE

The bollard luminaire supports 1–10 V dimming as well as DALI dimming, allowing smooth and reliable adjustment of light output according to the required ambiance or energy-saving needs. By integrating with compatible lighting control systems, the brightness can be adjusted from full output to lower levels while maintaining stable performance.

- 1–10 V dimming: Simple analog dimming.
- DALI dimming: Digital, programmable dimming for advanced control.

This feature is ideal for pathways, landscapes, and architectural outdoor applications where lighting levels may need to be adjusted at different times of the night, improving visual comfort while reducing energy consumption

DIMENSIONAL DETAILS

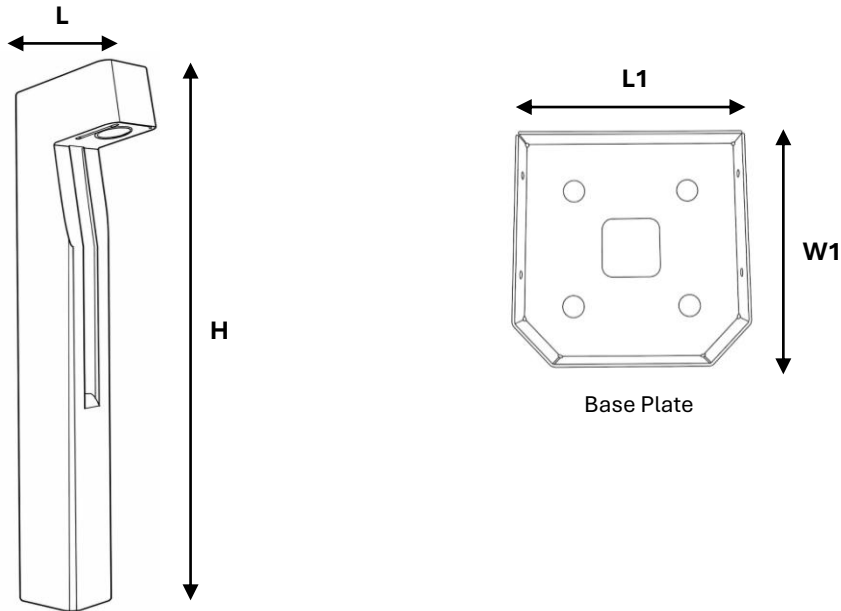

DIMENSIONS	
HEIGHT	1200 / 1000 / 600
LENGTH	212 mm
LENGTH (L1)	120 mm
WIDTH (W1)	120 mm

OPTICS & PHOTOMETRIC DETAILS

Polar Plot

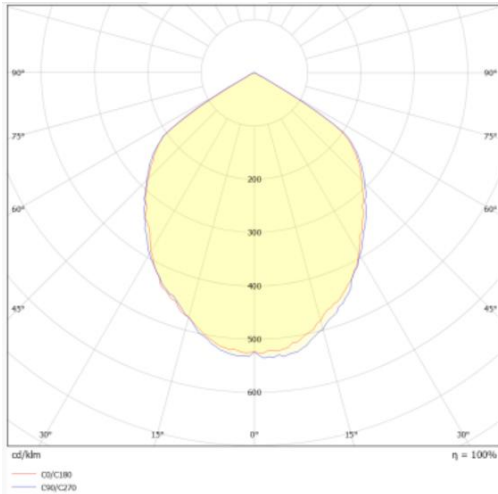

Linear Plot

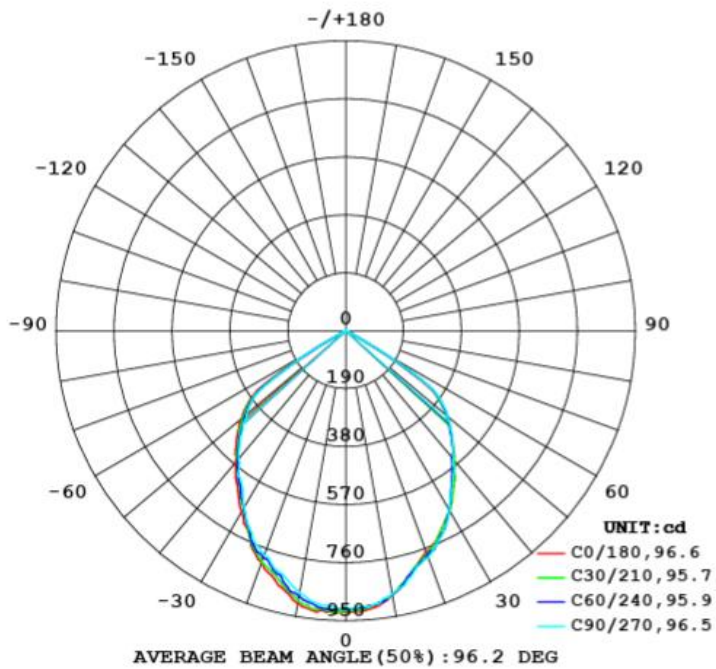
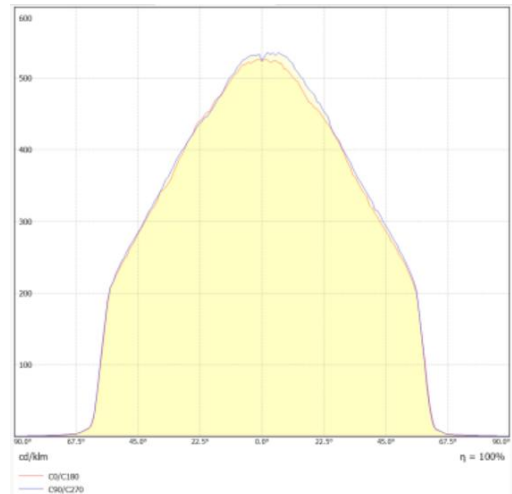

GENERIC INSTALLATION STEPS

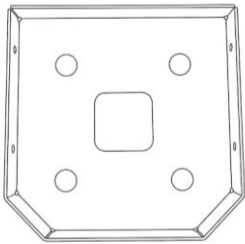

1. Base Preparation

Prepare a stable concrete base or mounting plate and route the power cable to the installation point.

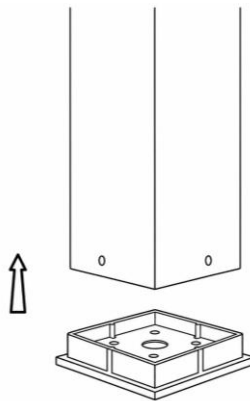

2. Fixture Mounting

Position the bollard on the base and secure it firmly using anchor bolts.

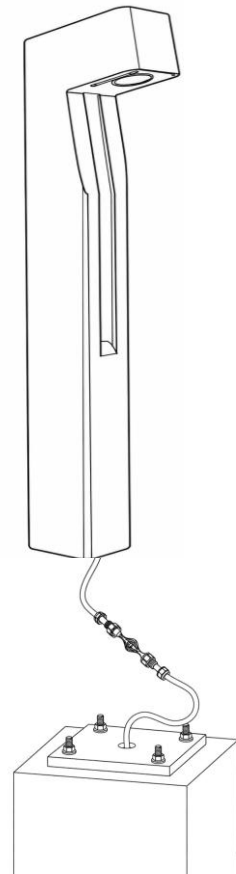

3. Wiring & Test

Connect the power cables as per the wiring diagram and switch on the power to test the luminaire.

Note:

- Use only suitably rated IP connectors (minimum IP66 or above) for all electrical connections.
- Where luminaire drivers are installed remotely, they shall be housed within appropriately rated IP enclosures to ensure protection against environmental ingress.



UNDERSTANDING BOLLARD HEIGHT SELECTION



MH: 600 mm



TH: 1000 -1200 mm

Medium Height Bollards (MH): (600 mm)
Ideal for balanced pathway lighting in residential and commercial outdoor spaces, With a medium-height configuration, it offers an optimal balance between visibility and visual comfort without overpowering the surroundings.

Tall Height Bollards (TH): (1000-1200mm)
Ideal for pathways, gardens, parks, and outdoor spaces, providing reliable illumination while enhancing safety and landscape aesthetics